

## **Research Summary Document – October 2007**

# **Two Year ClarityCap Research Programme Finally Answers An Audio Capacitor's Influence On Sound Quality**

ClarityCap have been supplying high-quality audio capacitors to some of the world's top HiFi and loudspeaker manufacturer for over 20 years. During that time, we have developed an enviable reputation for producing high quality audio capacitors.

### **Need to Understand Underlying Technology**

During recent years, it has become clear that, to stay ahead of the competition and keep producing audio capacitors of the highest quality, we needed a detailed understanding of what properties of capacitors affected the audio quality in hi-fi systems. Specifically, we wanted to understand the underlying technology of our capacitors, without looking at exotic materials and strange assemblies.

We therefore set up a 2 year project with the Acoustics Research Centre (ARC) at the University of Salford, renowned experts in the field of audio and acoustics, to investigate the material properties of audio capacitors.

This research programme was undertaken as part of the UK Department of Industry Knowledge Transfer Partnership programme. The research is part funded by the British Government and part by the company with the University offering their research facilities as part of the arrangement. The University and company appointed Paul Dodds, a post graduate Electronics Engineer to work exclusively on the research for the full 2 year period. During the period he had extensive contact with a number of world renowned loudspeaker engineers gathering their thoughts on capacitor performance and the effects that the components had within their finished products.

During the course of this in-depth investigation, we measured as many of our components as possible and even examined competitor products in so much detail that we believe in many cases we may understand them better than our competitors do!

### **Initial Investigations**

Well over 300,000 individual measurements were taken on a huge range of capacitors using all available voltage ratings and aspect ratios. A state-of-the-art component analyser and automation system was used to gather an enormous amount of data.

Metallised film capacitors have excellent electrical properties that make them ideal for use as audio capacitors. They have an inherently low Equivalent Series Resistance (ESR) in the order of milliohms.

One criticism levelled at many types of capacitor wound from film is the stray inductance found inside the component. Figure 1 shows a basic equivalent circuit of a capacitor, where L is the stray inductance of the capacitor including that of the leads, C is the capacitance and R is the ESR.

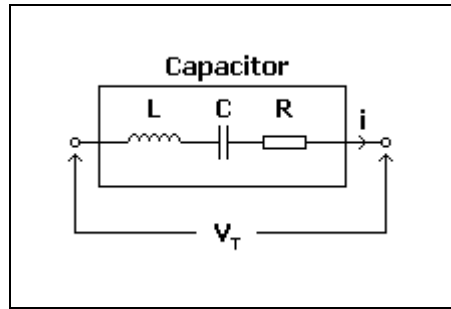

Figure 1: Basic equivalent circuit of capacitor

The phasor diagram of this system is shown in figure 2.

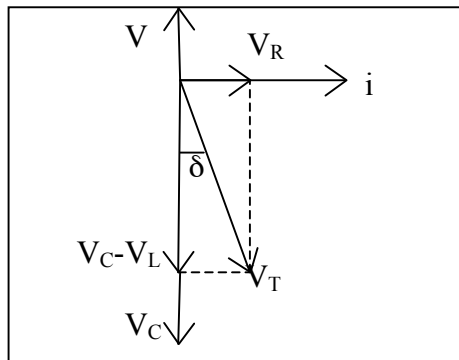

Figure 2: Phasor diagram of capacitor equivalent circuit

When multiplying through by the current,  $i$ , to obtain impedances for each individual element, the following transformations occur:

$$V_L \rightarrow \omega L, \quad V_R \rightarrow R, \quad V_C \rightarrow \frac{1}{\omega C}$$

The impedance of the capacitor's equivalent circuit can be found using:

$$|Z| = \sqrt{R^2 + \left(\frac{1}{\omega C} - \omega L\right)^2}$$

Where:

- $Z$  is impedance (ohms)
- $R$  is ESR (ohms)
- $\omega$  is frequency (rad/s)
- $C$  is capacitance (F)
- $L$  is inductance (H)

This implies that any stray inductance gives rise to a capacitance that increases sharply with frequency. It is easy to understand why that would be a problem in audio systems, where several octaves will be covered by a single driver!

When ClarityCap make capacitors, we short all of the turns out by spraying the end of the capacitor with metal. This has several benefits. The first is that it provides an excellent end connection with low resistance and high mechanical strength [Ref.1].

However, importantly, it virtually eliminates all of the stray inductance due to the winding of turns. The result is a capacitor with stable electrical properties and a smooth frequency characteristic.

**However, after all of the electrical measurements were taken, we drew a blank when it came to explaining the audible differences between capacitors - as expected, there were small variations in terms of ESR but nothing that explained the differences we could hear when listening to the capacitors.**

## **Mechanical Resonances**

Then, we began to investigate a key feature of audio capacitors: the mechanical resonance. This is a physical deformation of the capacitor walls which occurs as a result of the audio signal passing through the component – much like an electrostatic speaker. This resonance is dependent on the size, shape, materials and manufacturing parameters of the capacitors. This effect has been known about for years as it plays a part in the impulse strength of capacitors. However, the effect has never been considered to be significant enough to affect a hi-fi system's audio reproduction due to the low energy involved.

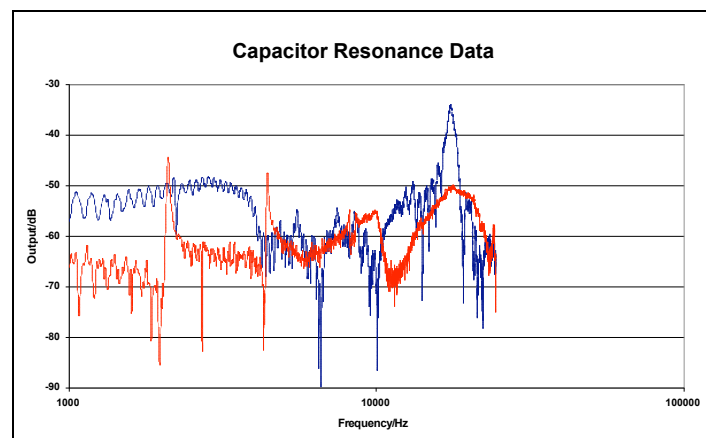

In order to investigate it properly, we developed two new and innovative excitation and measurement techniques. The first was based upon a continuous swept sine wave being applied to the component. The second, using unique in-house designed equipment, determined an impulse response for the capacitor.

However, the key moment was when we found that these two traces aligned almost perfectly. When further research showed a phase change at the peak frequency, we knew we had identified a resonance in the capacitor.

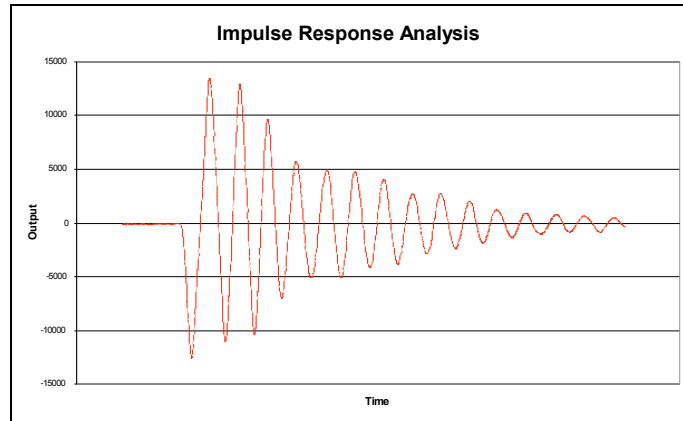

Analysis of the vibrations generated by both of these methods yielded several interesting features. For instance, a lot of detail can be obtained about the manufacturing process.

The resonances always occurred between 5 and 25kHz – exactly the range of frequencies where the capacitors would be used! We characterised the resonances for a huge variety of capacitor types, values, sizes and shapes and examined many competitor products too. All, without exception, followed this pattern.

These resonances have been examined and measured at the micron level using laser vibrometry at ARC. The discovery and characterisation of these mechanical resonances was outlined in our paper given at the Institute of Acoustics conference on Reproduced Sound in November 2006 [Ref.2].

### The Effect on Sound Quality

The next challenge was to identify whether these resonances had an effect on the sound quality of a system – and on what aspects of the sound. We conducted listening tests in the specialist listening facilities at the University of Salford which have shown conclusively the effect these resonances have on sound quality.

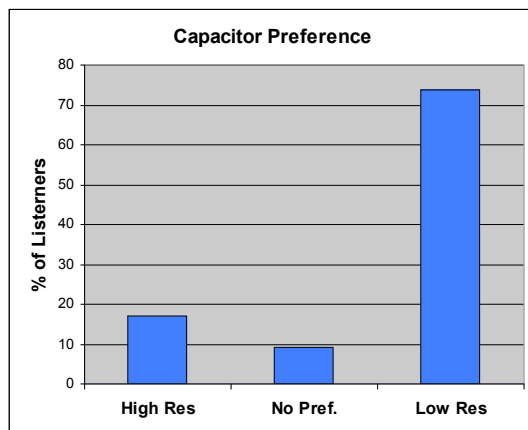

We designed capacitors with differing resonances and asked the panel to compare them to each other. The tests were blind and based on the ITU-R BS.1116-1 standard; they involved an independent panel of over 30 listeners.

The listeners were asked for their opinions on the sonic differences between the capacitors and to identify the characteristics of the sound that had been affected. They were also asked to state a

preference, if possible, between the capacitors.

**The results were dramatic – over 70% stated a clear preference for the capacitors with lower mechanical resonances.**

Most importantly, the tests helped us to identify how different properties of the capacitors affected different properties of the reproduced sound. We were able to identify the manufacturing factors which affect the clarity and spatial detail in our audio capacitors.

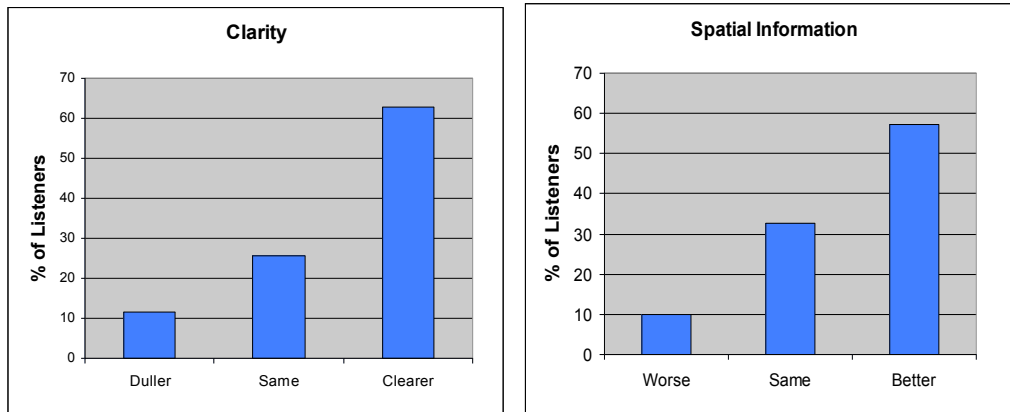

## The Mechanism

The answer to how these resonances occur requires some background in capacitor technology. Metallised film capacitors are effectively multi-layered devices: a laminated structure, consisting of the interleaved plates of the capacitor.

When charged, the capacitor plates are attracted to each other, forming a compressive force across the body of the capacitor. During discharge, this force is released and the plates return to their resting position. Since the force between the plates of a charged capacitor is always attractive, driving with a sine wave, like an audio signal, will produce a mechanical force at twice the driving frequency; an example of this 'frequency doubling' effect is shown below. This raises the issue of the capacitor being a possible source of intermodulation distortion products at double the frequency of any audio signals present.

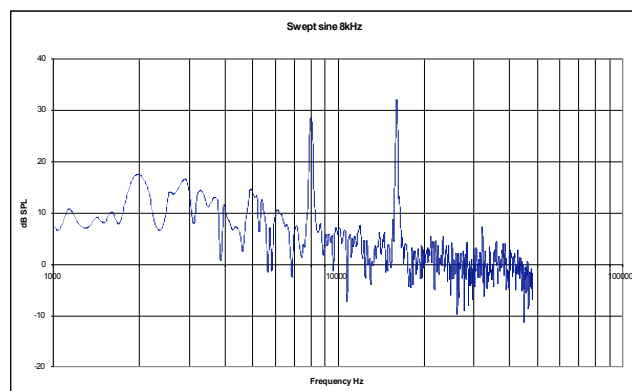

## The Perfect Capacitor?

Armed with this knowledge, we set about designing a capacitor with the lowest possible resonances. We examined the manufacturing process in fine detail and identified the key processes that determine the mechanical resonance of a capacitor. We developed a matrix of the parameters and tested every combination to find the optimum solution – and we found it! The graph below shows how we arrived at the lowest possible resonance capacitor.

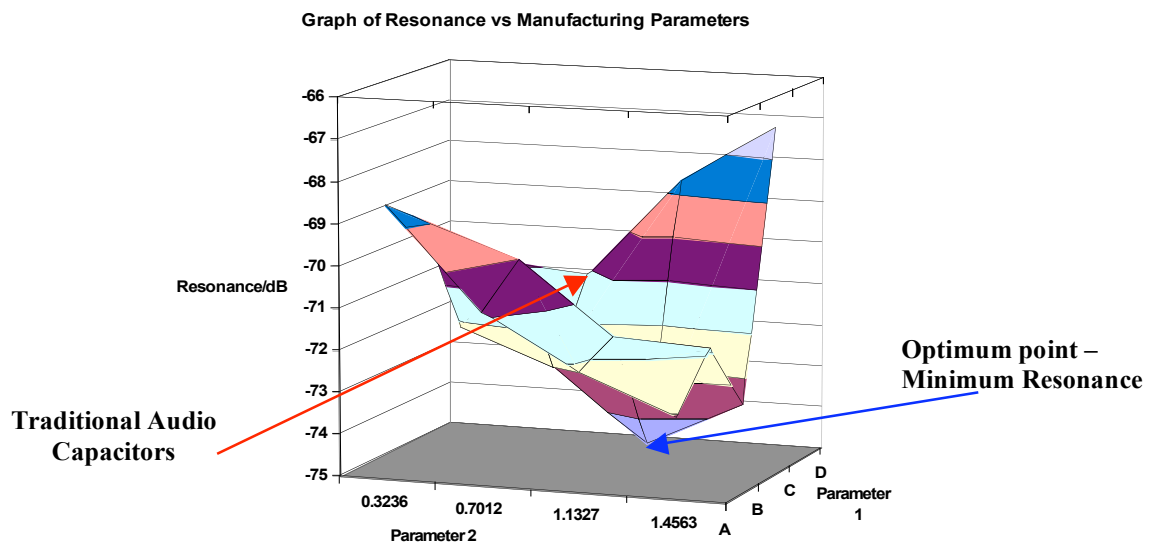

## The Way Ahead

We are currently working on bringing a product utilising this knowledge to market. Further information will be available before the end of 2007.

## References

1. N. Williams, Metallised Film Capacitors for High Frequency High Current Applications, IEE Colloquium on Capacitors & Inductors for Power Electronics, 7<sup>th</sup> March 1996.
2. P.S. Dodds, P.J. Duncan and N. Williams, Assessing The Effects Of Loudspeaker Crossover Components On Sound Quality, Proceedings of the Institute of Acoustics, Vol. 28. Pt.8 2006.

October 2007